

Detalle encuentro Fundacion - Muro  
ESCALA 1:5

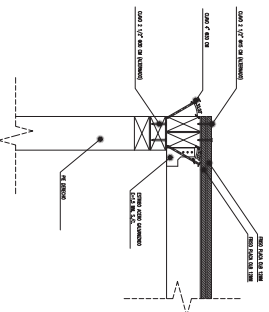

Detalle Entrepiso con Solera (Muro Perimetral)  
ESCALA 1:5

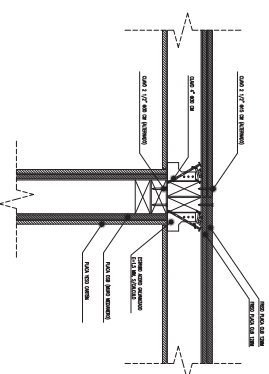

Detalle Entrepiso con Solera (Muro Medianero) - Nivel de Hold-down  
ESCALA 1:5

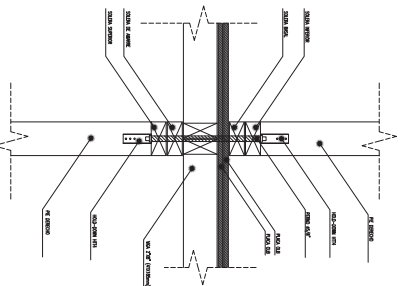

Detalle Solucion Analoga para encuentro con Muro Perimetral  
ESCALA 1:5

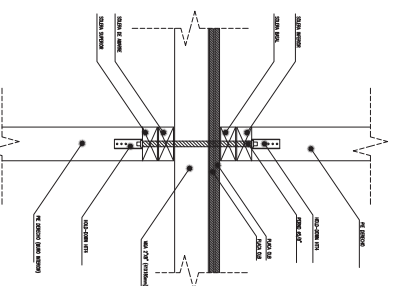

Detalle Entrepiso con Solera (Muro Interior) - Nivel de Hold-down  
ESCALA 1:5

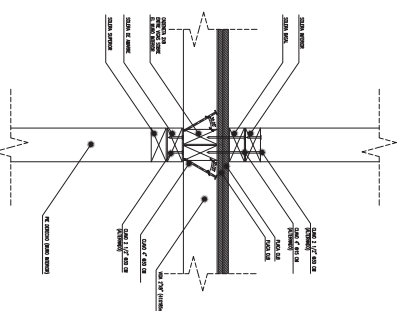

Detalle Entrepiso con Solera (Muro Interior)  
ESCALA 1:5

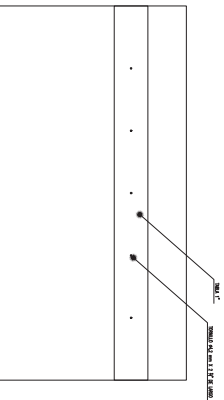

Detalle Soporte de Mueble  
ESCALA 1:5

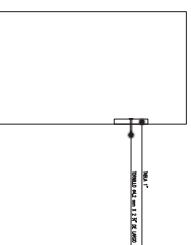

		 Tu mundo, tu estilo	
CONSULTORS			
		 DISEÑOYSIA S.A R.L.556.407-6	
 BO / arquitectura The highest of professionals		 SA LANTANA R.L.26.094-6	
PROYECTO: SISTEMA CONSTRUCTIVO MASISA OLB			
CONTENIDO:			
DETALLES			
CUADRO:	ESCALA:	INDICADOS	
FECHA: 20/11/15	PERSONA:	REV:0	

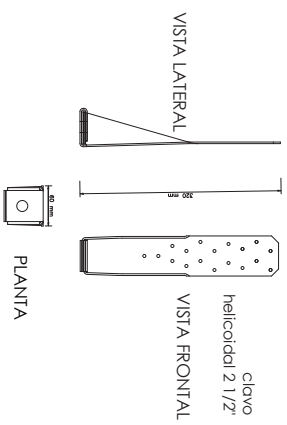

Detalle Hold Down HT14 SD #10 x 1/2"  
ESCALA 1:10

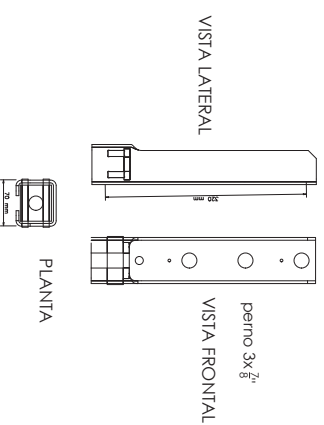

Detalle Hold Down HD99# 2 1/2"  
ESCALA 1:10

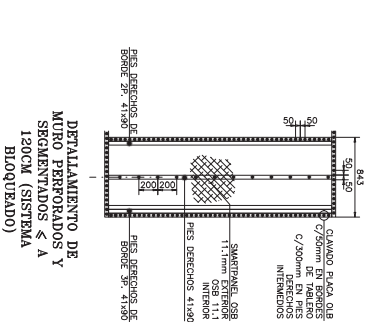

Detalle Entrepiso con Solera (Muro Medianero) - Nivel de Hold-down  
ESCALA 1:10

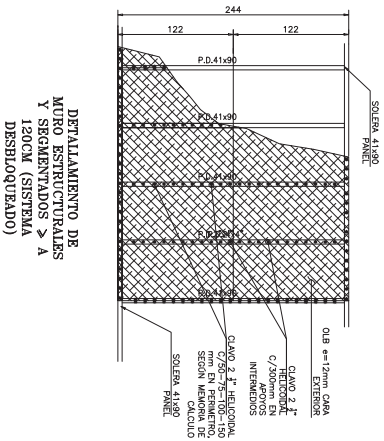

Detalle union esquina muros y tabiques  
ESCALA 1:10

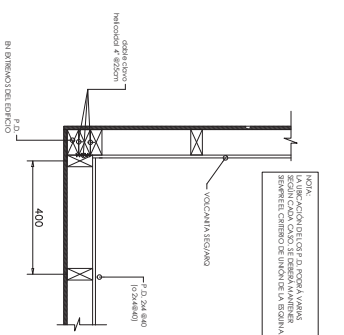

Detalle union encuentro muros  
ESCALA 1:10

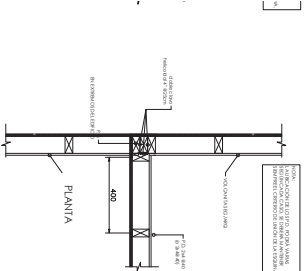



Detalle union encuentro muros  
ESCALA 1:10

**DETALLAMIENTO DE MURO ESTRUCTURALES Y SEGMENTADOS > A 120CM (SISTEMA DESBLOQUEADO)**

**PLANTA**

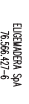
**PLANTA**

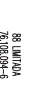
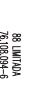
<b>PROYECTE</b>	<b>PROYECTO</b>
<b>CONSULTORES</b>	  
<b>PROPIETARIO</b>	 
<b>CONTRATANTE</b>	
<b>CONTENIDO</b>	<b>SISTEMA CONSTRUCTIVO MASISA OLB</b>
<b>DETALLES</b>	
<b>TAMAÑO</b>	ESCALA:
<b>FECHA</b>	DET 02/02 INICIADOS
<b>VERSIONE</b>	REV.0

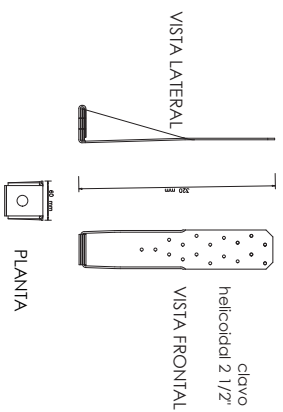

Detalle Hold Down HTTA SD #10 x 1/2"  
ESCALA 1:3

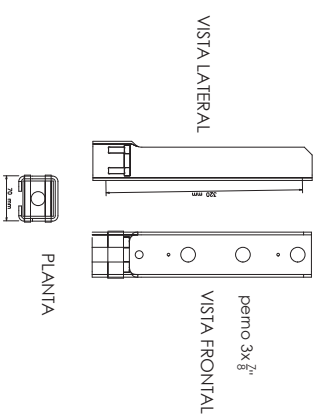

Detalle Hold Down HD98# 2 1/2"  
ESCALA 1:3

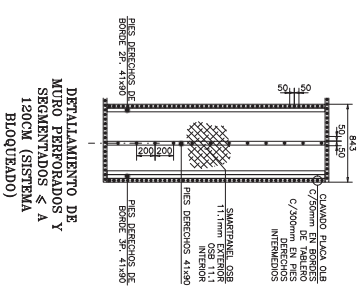

Detalle Entrepiso con Solera (Muro Medianero) - Nivel de Hold-down  
ESCALA 1:20

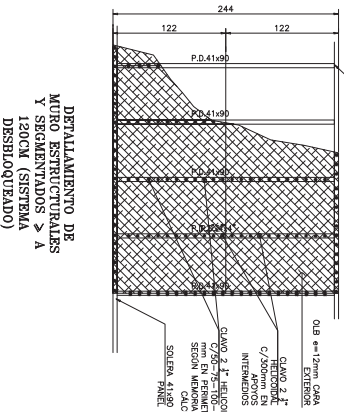

Detalle muros estructurales.  
ESCALA 1:5

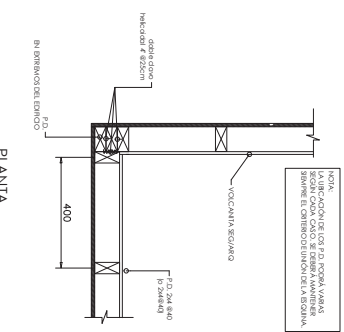

Detalle unión esquina muros y tabiques  
ESCALA 1:10

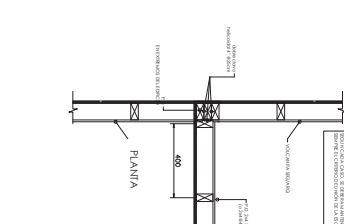

Detalle unión encuentro muros  
ESCALA 1:10

PROYECTO:		CONSTRUCCIONES	
SISTEMA CONSTRUCTIVO MASSA OLB		DISEÑADORA SA	
PROYECTO: 88 LINDUNA		N°366-07-8	
PROYECTO: 88 LINDUNA		N°18304-8	
PROYECTO: 88 LINDUNA		N°18304-8	
PROYECTO: 88 LINDUNA		N°18304-8	
CONTENIDO:		CONTENIDO:	
DETALLES		DETALLES	
UNIDAD:	ESCALA:	UNIDAD:	ESCALA:
DET 02/02	INDICADOS	DET 02/02	INDICADOS
FECHA:	VERSION:	FECHA:	VERSION:
2021.11.15	REV0	2021.11.15	REV0

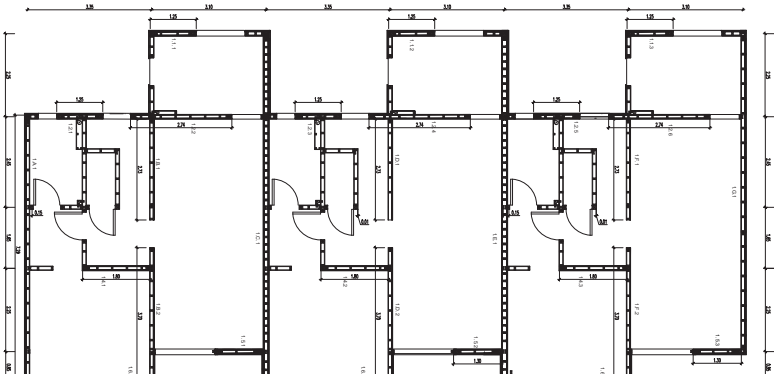

Planta Estructura Piso 1 Nivel  
0.00  
ESCALA 1:50

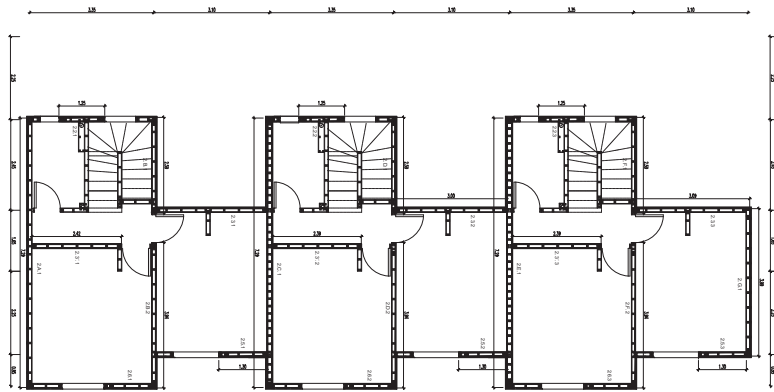

Planta Estructura Piso 2  
Nivel +2.60  
ESCALA 1:50

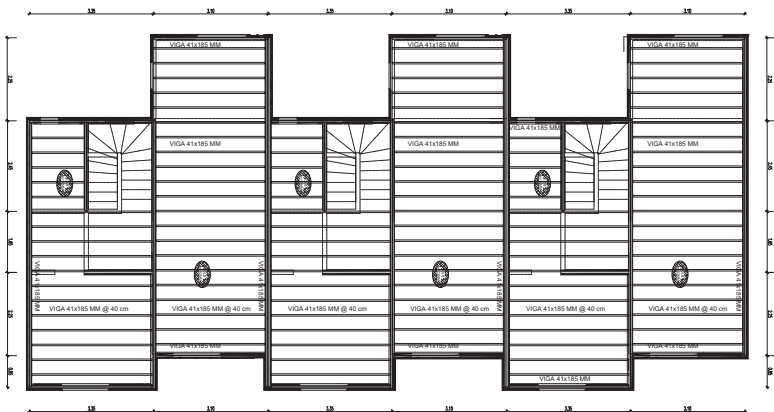

Planta Estructura de Entrepiso  
Nivel +2.60  
ESCALA 1:50

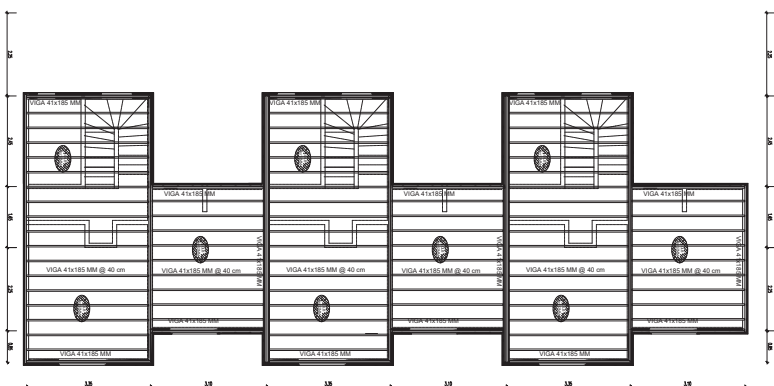

Planta Estructura de Cubierta  
Nivel +5.40  
ESCALA 1:50

Elevación Estructural EJE 6  
ESCALA 1:50

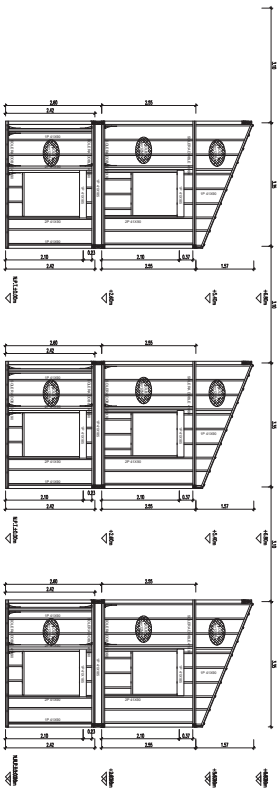

PROYECTO:  
**MASISA**  
TU FUTURO. TU ESTILO

CONSULTORES



ELIQUENA S/A  
TEL: 566427-5



88 Limitada  
ZARAVIA  
TEL: 8099-4

PROYECTOR:

SISTEMA  
CONSTRUCTIVO  
MASISA OLB

CONTENIDOS:

VIVIENDA CONTINUA

UNIDAD: ESCALA:

EST: 04/05 INDICADOS

FECHA: 2021.11.15

VERSION: REV.0

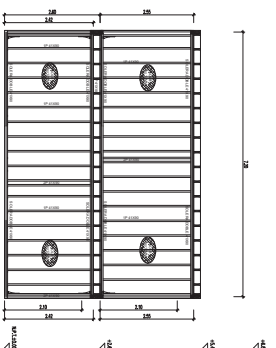

Elevación Estructural EIE A  
ESCALA 1:50

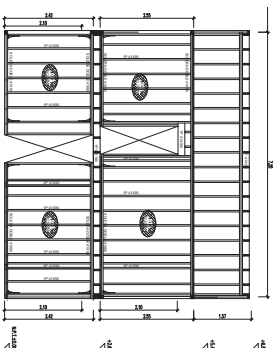

Elevación Estructural EIE B - EIE D - EIE F  
ESCALA 1:50

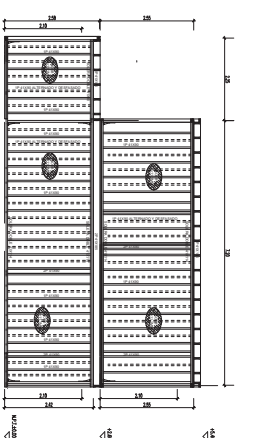

Elevación Estructural EIE C - EIE E  
ESCALA 1:50

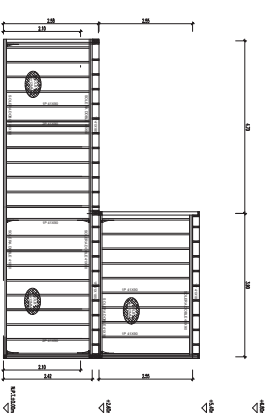

Elevación Estructural EIE G  
ESCALA 1:50

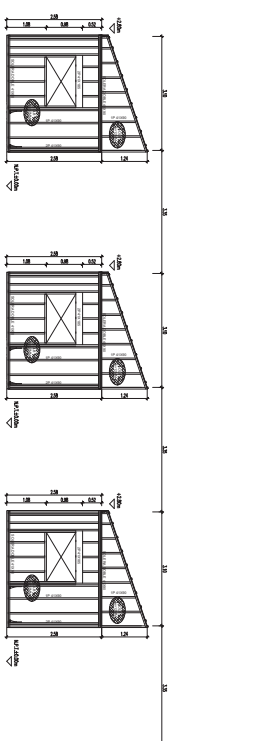

Elevación Estructural EIE 1  
ESCALA 1:50

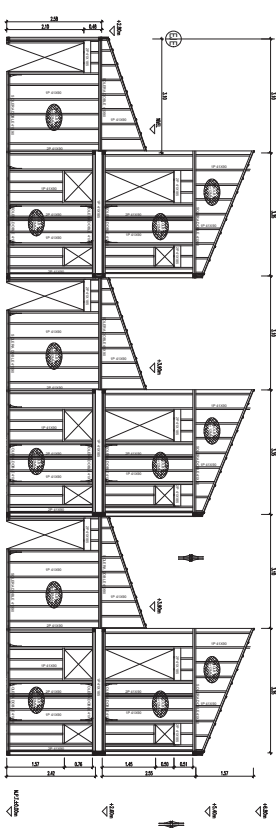

Elevación Estructural EIE 2  
ESCALA 1:50

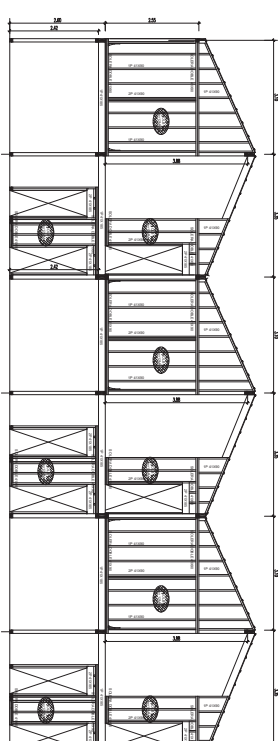

Elevación Estructural EIE 3  
ESCALA 1:50

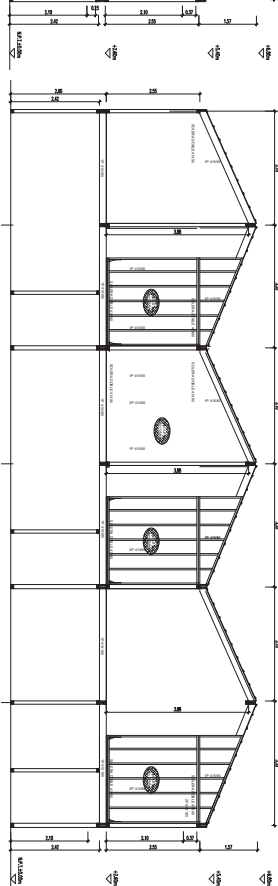

Elevación Estructural EIE 3'  
ESCALA 1:50

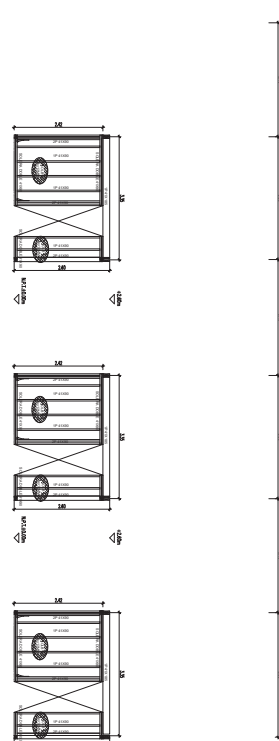

Elevación Estructural EIE 4  
ESCALA 1:50

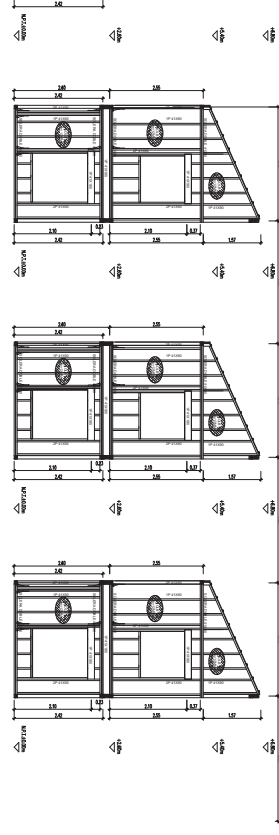

Elevación Estructural EIE 5  
ESCALA 1:50

PROPIETARIO:

**MASISA**  
CONSTRUCCIONES Y OBRAS

CONSULTORES:

**INGENIERIA**

ELIZABETH S.A.  
R.C. 19.566.477-6

**PROYECTO:**  
88 LINDA  
76.182.094-6

SISTEMA  
CONSTRUCTIVO  
MASISA OLB

COMENTARIOS:  
VARIACION CONTINUA

LAJAS  
EST 05/05  
INDICADOS

FECHA:  
2021.11.15

VERSION:  
REV.0

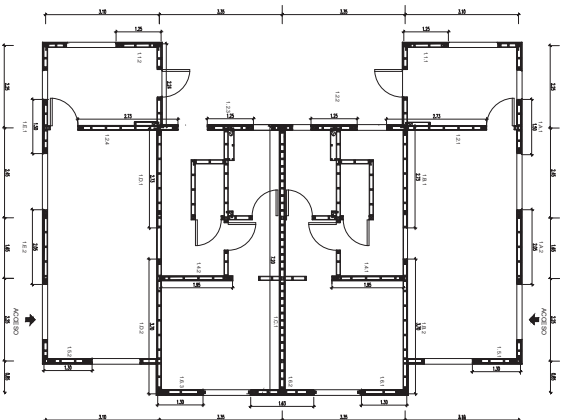

Planta Estructural Piso 1 Nivel  
0.00  
ESCALA 1:50

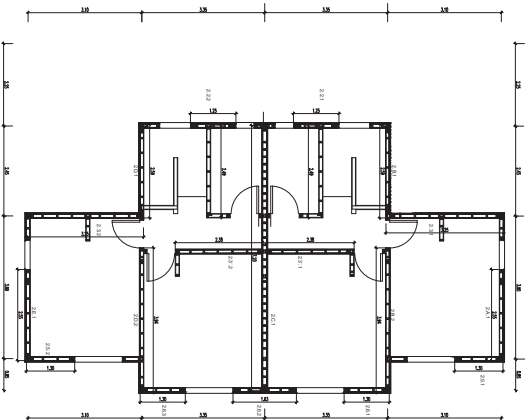

Planta Estructural Piso 2  
Nivel +2.60  
ESCALA 1:50

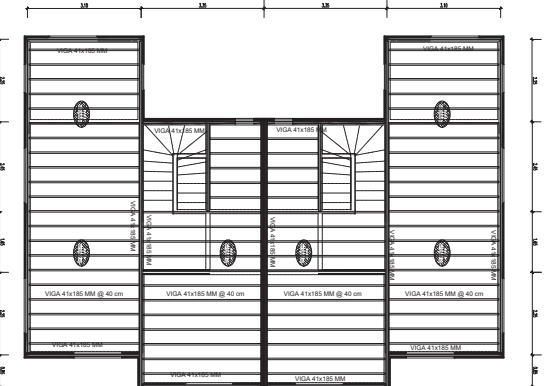

Planta Estructura de Entrepiso  
Nivel +2.60  
ESCALA 1:50

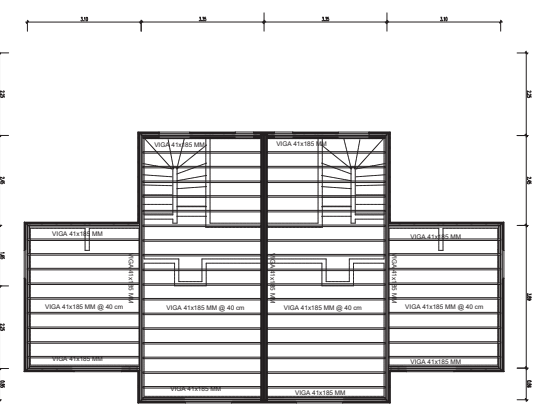

Planta Estructura de Cubierta  
Nivel +5.40  
ESCALA 1:50

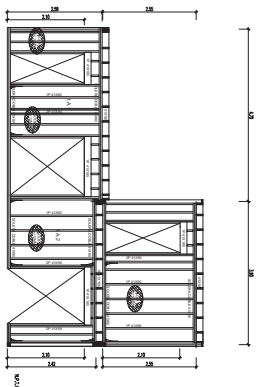

Elevación Estructural EIE A - EIE E  
ESCALA 1:50

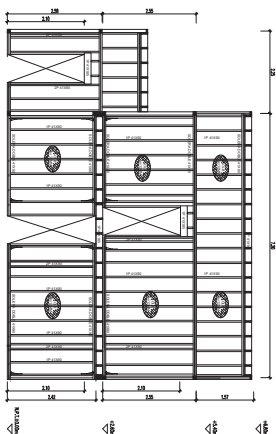

Elevación Estructural EIE B - EIE D  
ESCALA 1:50

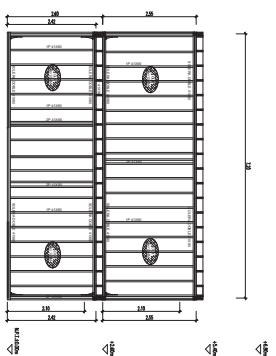

Elevación Estructural EIE C  
ESCALA 1:50

PROYECTOR

**MASISA**  
10 años de experiencia en el sector

CONSULTORES

**INGENIA-ARSA**

DESARROLLO S.A

76.585.471 - 6

**ESB** 

88 LIMA S.A

76.183.024 - 6

PROYECTO

SISTEMA  
CONSTRUCTIVO  
MASISA OLB

CONTRATANTE

VIVIENDA PREFABRICA (1)

CLIENTE

EST 02/05 INDICADORES

FECHA 2021.11.15 VERSION R3.00

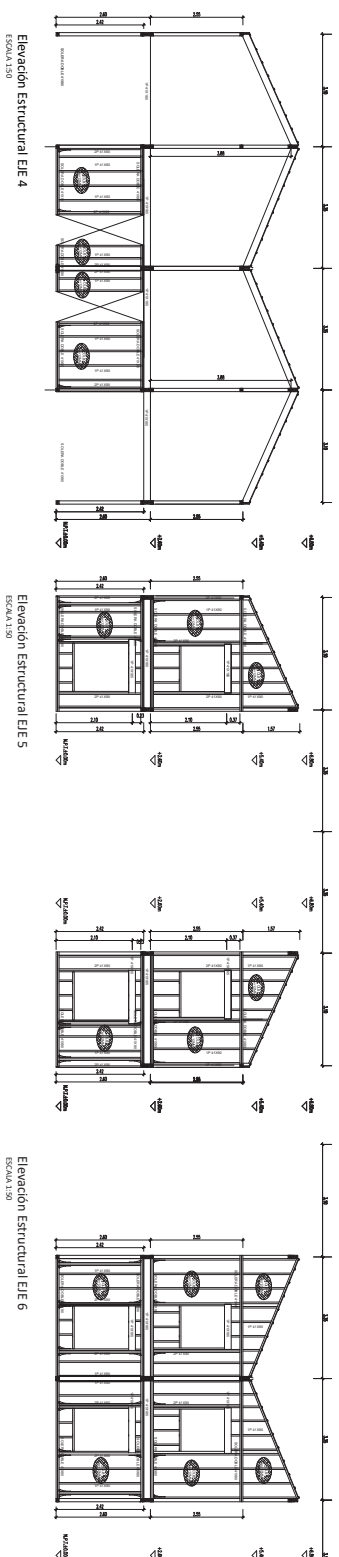
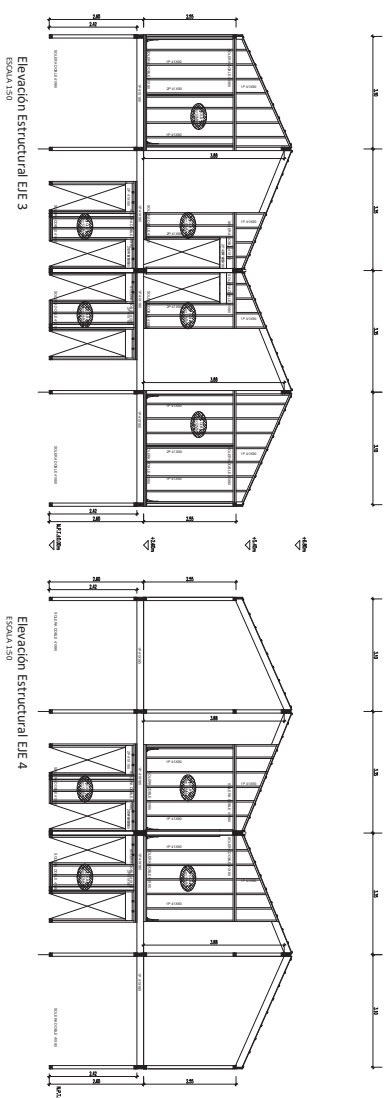
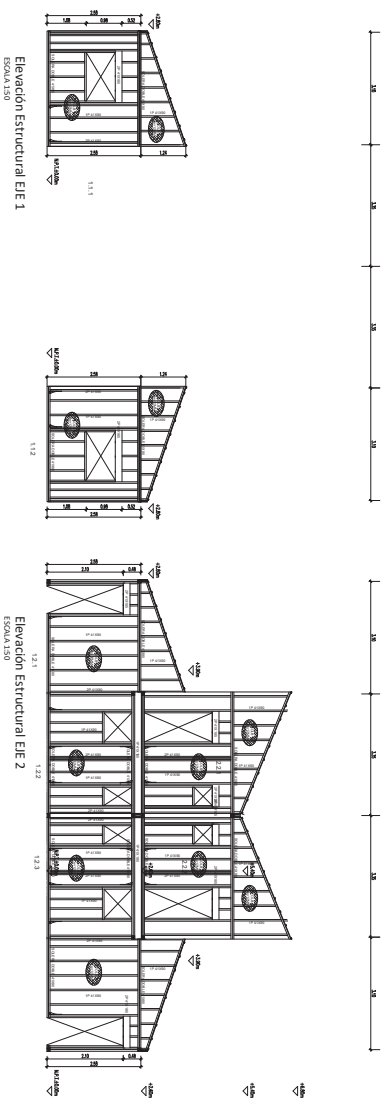

PROYECTO		SISTEMA CONSTRUCTIVO MASISA OLB	
CONTRATANTE		VIÑEDA PAREADA (2)	
TÍTULO		ESCALA	
EST. 03/05		INDICADOS	
FECHA		PERSONA	
2021.11.15		REVO	



ELABORADA POR  
ING. OSCAR E. G.



SA LUTINA  
ZERONEN-4

PROYECTO  
SISTEMA CONSTRUCTIVO  
MASISA OLB

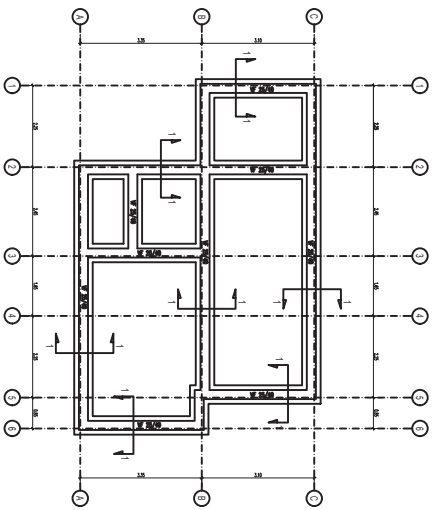

VIVIENDA ASLADA - PLANTA FUNDACIONES  
ESCALA 1:50

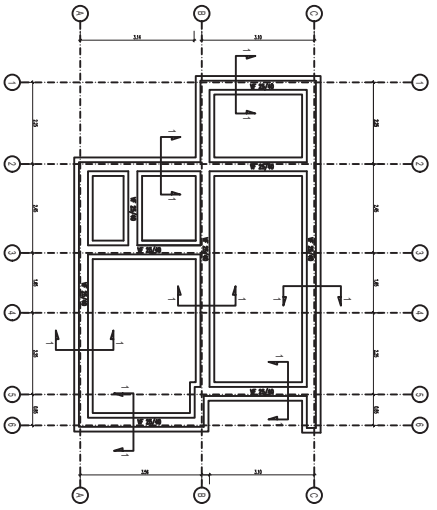

VIVIENDA CONTINUA - PLANTA FUNDACIONES  
ESCALA 1:50

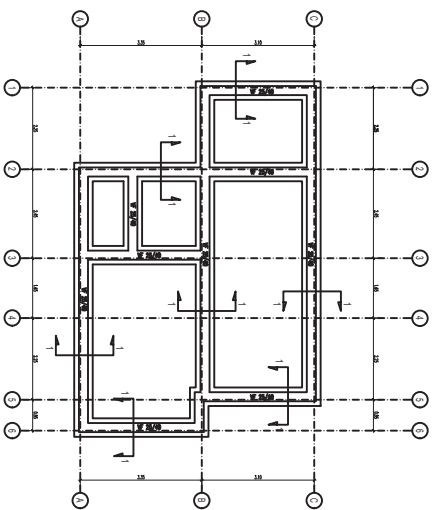

VIVIENDA PAREDADA - PLANTA FUNDACIONES  
ESCALA 1:50

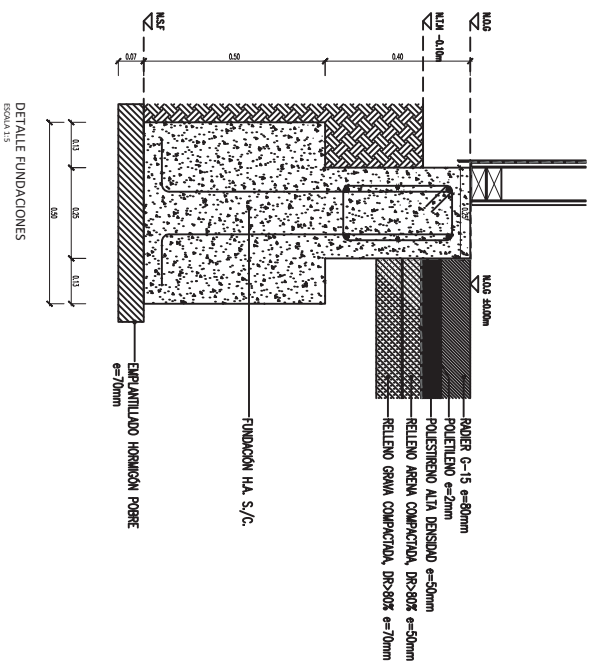

DETALLE FUNDACIONES  
ESCALA 1:5

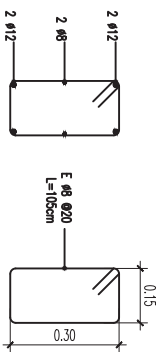

PROYECTAR:

**MASISA**  
TU MUNDO, TU ESTILO

CONSULTORES:

**ALCANTARA**

DESIGNER S/A  
R.S.N. 677-4

888 Limitada  
C.R. 11177-1

888 Limitada  
C.R. 11177-1

PROYECTO:  
**SISTEMA CONSTRUCTIVO MASISA QB**

TITULO:  
**DETALLE FUNDACIONES**

ESTADO:  
**INDICADOS**

FECHA:  
**2021.07.02**